

# SH 120-T02V

## Economical Steel Articulating Monitor Arm

Fits Most 13"-32" Monitors



**Also Fits  
Curved Monitors**

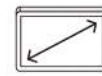
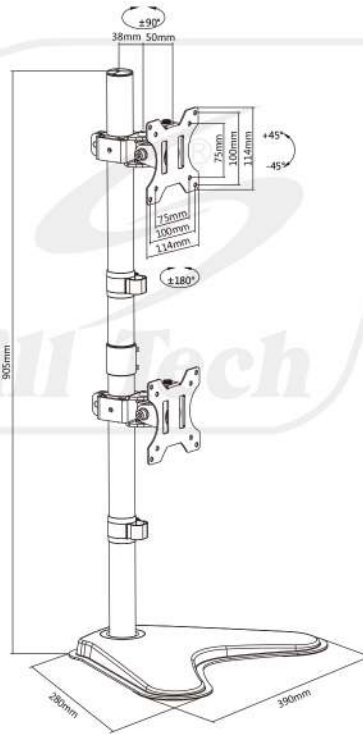

Screen Size  
**13"-32"**



Weight Capacity  
**8kg/17.6lbs**



Tilt Range  
**+45° ~ -45°**

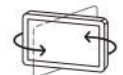

Swivel Range  
**+90° ~ -90°**



Screen Rotation  
**360°**

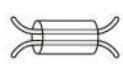

Cable  
Management

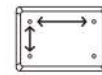

VESA Compatible  
**75x75 100x100**



**Portrait and Landscape Orientation.**

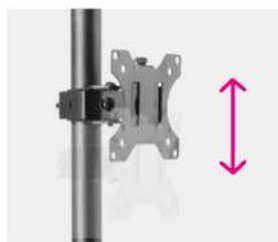

**Vertical Height Adjustable** for an optimal viewing experience.



**Freely Tilting** for a desired viewing angle.

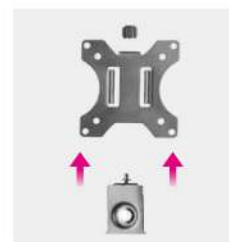

**Detachable VESA Plate** enables easy installation.



**Cable Management** for an organized and neat workspace.